

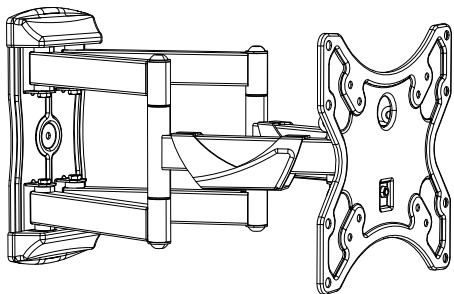











# SMART Q



- |  |   |   |   |   |
|--|---|---|---|---|
|  M6X12MM<br>A(4PCS)  |  M8X12MM<br>B(4PCS) |  M8X20MM<br>C(4PCS) |  M8X45MM<br>D(4PCS) |  M4X45MM<br>E(4PCS) |
|  M4X20MM<br>F(4PCS) |  M6<br>G(4PCS)     |  M6<br>H(4PCS)     |  M6<br>I(8PCS)     |  L1(4PCS)          |
|  L2(4PCS)           |   |   |   |   |

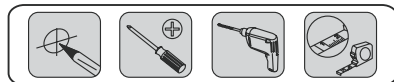

## STEP 2 Agganciare la piastra allo schermo

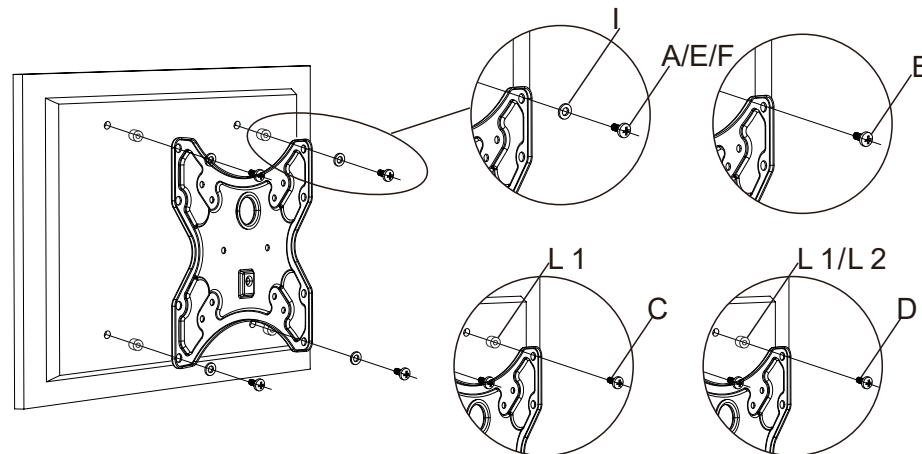

All'occorrenza usare i distanziatori L

## STEP 1A Montaggio su cemento pieno

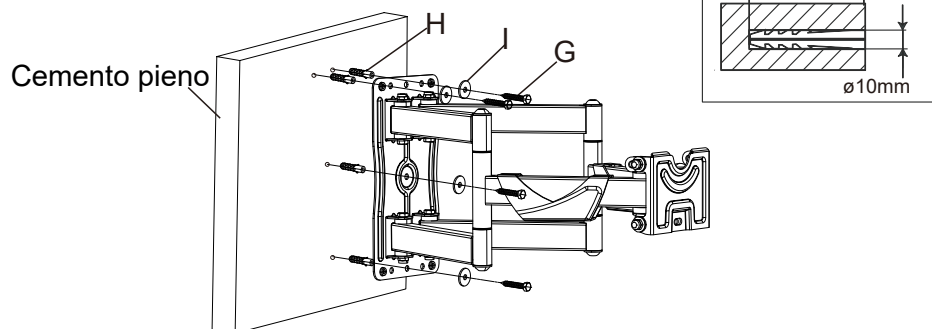

## STEP 1B Montaggio su legno pieno

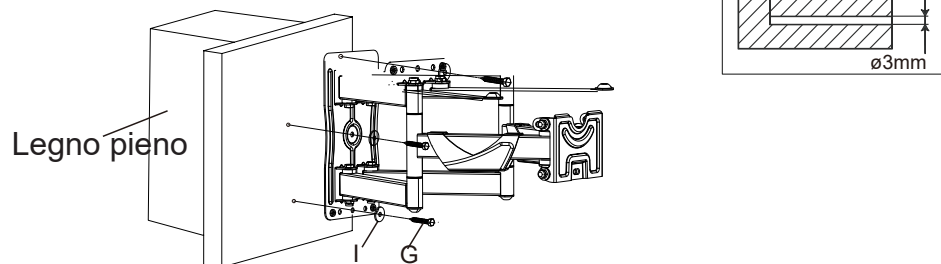

**ATTENZIONE:** Il muro su cui installare il supporto deve essere pieno, stabile e sicuro. Il produttore non si assume nessuna responsabilità in caso di ancoraggio non corretto o impiego diverso dal sostegno di TV.

## STEP 3 Agganciare la TV sul braccio

